

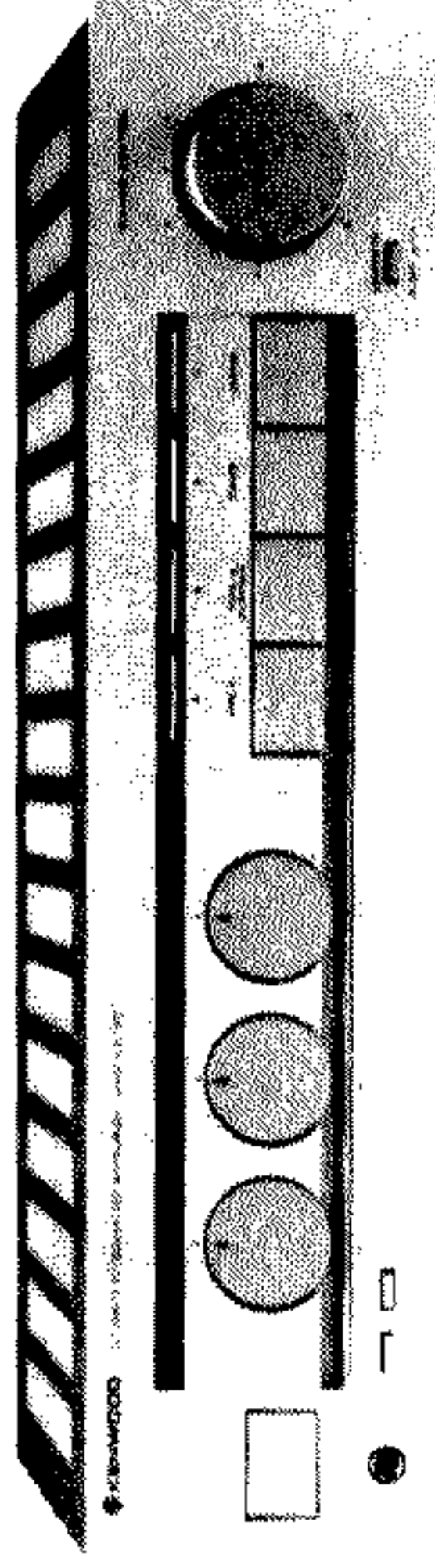

INTEGRATED AMPLIFIER

KA-50



SPECIFICATIONS

Power output
45 watts* per channel minimum RMS, both channels driven, at 8 ohms from 20 Hz to 20,000 Hz with no more than 0.09% total harmonic distortion.

Total Harmonic Distortion

AUX input to SPEAKER output
(20 Hz to 20,000 Hz)0.09% at rated power into 8 ohms
(20 Hz to 20,000 Hz)0.06% at 1/2 rated power into 8 ohms

PHONO input to SPEAKER output(1 kHz)

PHONO input to SPEAKER output(1 kHz)0.06% at rated power with VOLUME - 20 dB
Intrinsic Distortion0.06% at rated power into 8 ohms
Damping Factor30 (1 kHz into 8 ohms)
Power Bandwidth20 Hz to 35,000 Hz at 0.2% T.H.D.

Frequency Response10 Hz to 70 kHz, +0 dB -3 dB

Input Sensitivity/Impedance

Phono2.5 mV/50 ohms
Tuner,AUX,Tape150 mV/30k ohms
Signal-to-Noise Ratio(IHF-A)
Phono72dB for 2.5 mV input
78 dB for 5.0 mV input
84 dB for 10 mV input
100dB for 150mV input
Phono Maximum Input Level . . .170 mV (RMS), T.H.D. 0.05% at 1,000 Hz

Output Level/Impedance

Tape REC(Pin)150 mV/2.2 k ohms
Phono Frequency Response . . .RIAA standard curve ± 0.3 dB (20 Hz to 20,000 Hz)

Tone Control

Bass ± 10 dB at 100 Hz
Treble ± 10 dB at 10 kHz
Loudness Control+9 dB at 100 Hz (at -30dB VOLUME Level)

GENERAL

Power Requirements60 Hz 120 V(U.S.A. & Canada Model) or 50/60 Hz 110~120 V/220~240 V switchable
Power Consumption1.8A(UL and CSA) 150 W

180 W(8 ohms at rated power)
38 W(No signal)

A.C. Outlet

Switched 2, Unswitched 1

Dimensions

W 440 mm (17-5/16")
H 109 mm (4-19/64")
D 249 mm (9-51/64")

Weight

5.5 Kg(12.1 lbs)

Kenwood follows a policy of continuous advancements in development. For this reason specifications may be changed without notice.
Kenwood poursuit une politique de progrès constants en ce qui concerne le développement. Pour cette raison, les spécifications sont sujettes à modifications sans préavis.

Kenwood strebt ständige Verbesserungen in der Entwicklung an. Daher bleiben Änderungen der technischen Daten jederzeit vorbehalten.

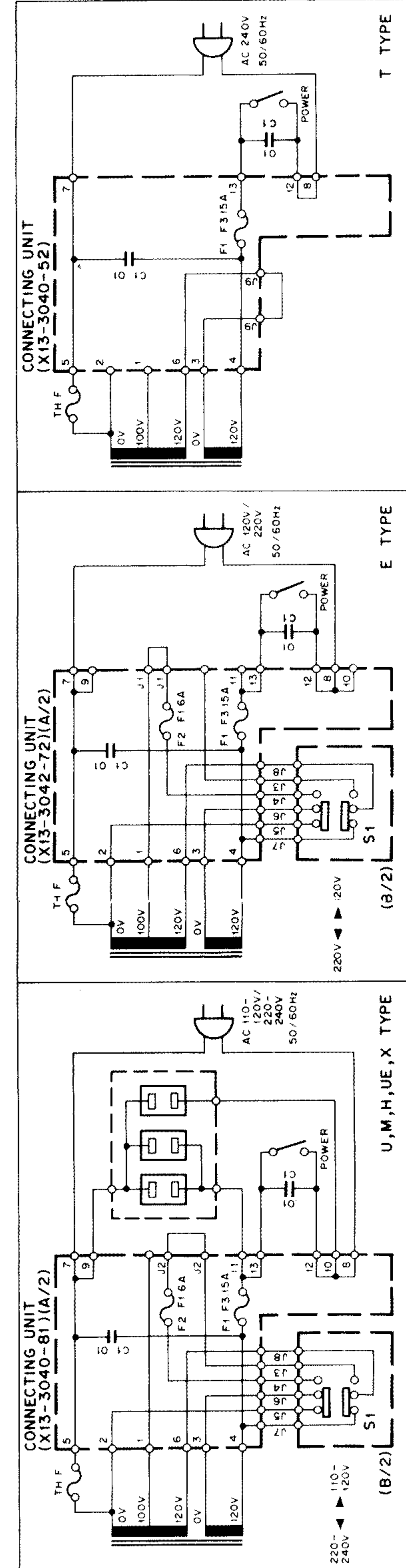


- Q1~4 : 2SA992(F,E) or 2SA921(S,T)
- Q5,6,21,22 : 2SC1845(F,E) or 2SC945(A)(Q,P) or RC4558P
- Q7,8,18 : 2SC2320(F,E)
- Q9,10 : 2SA794(Q,R) or 2SA1110(Q,R)
- Q11,12 : 2SC1567(Q,R) or 2SC2590(Q,R)
- Q13~16 : W06B
- Q17 : GP25D or UO5(C,S)

IC1	AN6552 or JPC4558C or JPC457C or RC4558P
D1,2	WZ-157
D3,4	1S2076A
D21~25	1S2076 or 1S1555
D6,11~14	W06B
D7~10	GP25D or UO5(C,S)
VR1	25A733(A) or 2SA999
VR2	D1~10 B30-0275-05
VR3	D11 B30-0274-05
VR4	

DC voltages are measured by a VOM with 25k Ω /V input impedance.

- 2SA733
- 2SA794
- 2SA921
- 2SA992
- 2SA999
- 2SA110



- 2SC2579
- 2SC2580

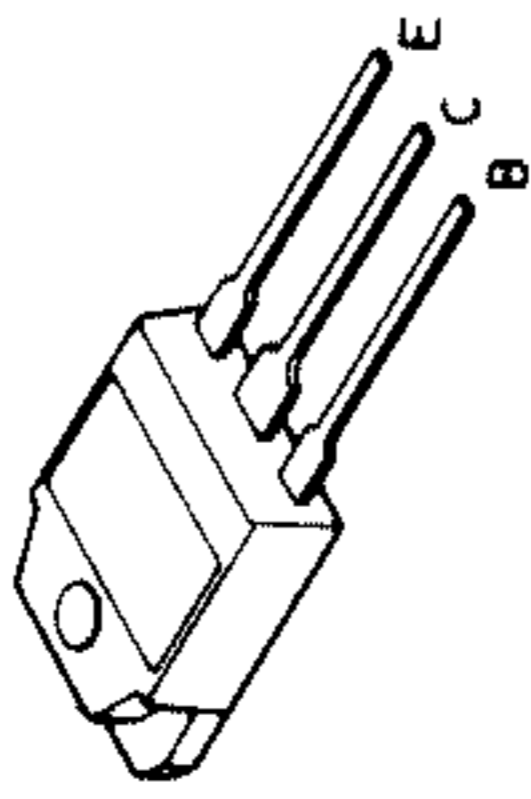

- AN6552

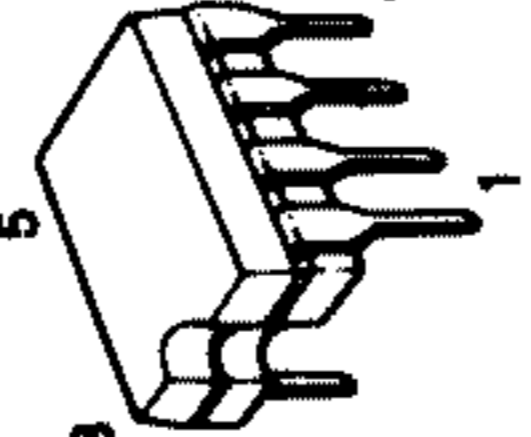

- RC4558P
- μPC4557C
- μPC4558C

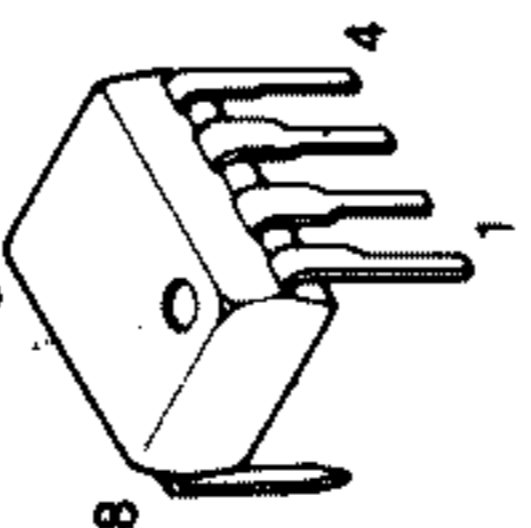

Semiconductor Name	Substitutions
2SA733(A)	2SA999
2SA794(Q,R)	2SA110(Q,R)
2SA992(F,E)	2SA921(S,T)
2SC945(A)(Q,P)	2SC2320(F,E)
2SC1567(Q,R)	2SC2590(Q,R)
2SC1845(F,E)	2SC2003
2SC2003(L,K)	2SC1885
2SC2579	2SC2580
AN6552	μPC4558C
	μPC4557C
	RC4558P



- Q1~4 : 2SA992(F,E) or 2SA921(S,T)
- Q5,6,21,22 : 2SC1845(F,E)
- Q7,8,18 : 2SC945(A)(Q,P) or 2SC2320(F,E)
- Q9,10 : 2SA794(Q,R) or 2SA110(Q,R)
- Q11,12 : 2SC1567(Q,R) or 2SC2590(Q,R)
- Q13~16 : 2SC2579
- Q17 : 2SC2003(L,K)

- IC1 : AN6552 or μPC4558C or μPC4557C or RC4558P
- D1,2 : WZ-157
- D3,4 : 1S2076A
- D21~25 : 1S1555
- D6,11~14 : W06B
- D7~10 : GP25D or U05C(S)

IC1	Q1,2	Q3,4	Q5,6	Q7,8	Q9,10	Q11,12	Q13,14	Q15,16	Q17,18	Q19,20	Q21,22	Q23,24	Q25	VR1	VR2	VR3	VR4

DC voltages are measured by a VOM with 25kΩ